



OPERATION MANUAL UNIVERSAL BINARY SENSOR v2.1 - v2.3

The Universal Binary Sensor is a wireless module that makes it possible to improve the functionality of any sensor with a binary output by allowing it to communicate with the wireless network Z-WAVE and the FIBARO building intelligence system. Moreover, the module allows for wireless communication between the system and the DS18B20 temperature sensors. The device can service up to two binary sensors and up to four DS18B20 temperature sensors. The Sensor was designed for installation in the housing of a sensor or another device, the functionality of which we wish to improve.

The Universal Binary Sensor may be used whenever wireless collection of data from sensors is required. Once additional safety housing have been installed, the Sensor can also be used in areas with high humidity and high temperature. The Sensor's main function is the integration of the wireless Fibaro System with the existing wire-based and wireless alarm and measurement systems. As an element of the safety system the device is transparent for parametric alarm lines.

Technical data

Supply voltage:	9-30V DC ±10%
Input:	2 potential-free inputs, 1 digital input 1-wire
Output:	2 potential-free outputs
Maximum current carrying capacity of outputs:	150mA
Maximum voltage at output contacts:	36V DC / 24V AC ±5%
Operating temperature:	0 - 40 °C
Number of servicing temperature sensors:	4
Measurement range:	-55°C - +126°C
Radio signal power:	1mW
Radio protocol:	Z-Wave
Radio frequency:	868.4 MHz EU; 908.4 MHz US; 921.4 MHz ANZ; 869.2 MHz RU;
Range:	up to 30 m indoors (depending on the construction materials) up to 50m outdoors
Dimensions (L x W x H):	27,3 x 14,5 x 12 mm

Technical information

- Controlled with FIBARO system devices or any Z-Wave controller
- Microprocessor-based control
- Compatible with regular and parametric alarm lines (can be connected to 2 alarm detectors)
- Compatible with binary sensors (can be connected to 2 binary outputs)
- Compatible with DS18B20 temperature sensors (can be connected to four DS18B20 temperature sensors)
- In order to connect the DS18B20 sensors it is recommended to use conductors made from a single wire with a length of up to 30 meters

DANGER
The Sensor is powered with secure voltage; nevertheless, the user should be extra careful or should commission the installation to a qualified person.

- Hint**
The outputs of the device should not be loaded with a current value exceeding 150mA
- Hint**
Connections should be made specifically according to the diagrams presented in this manual. Incorrect connection may lead to hazards.

I GENERAL INFORMATION ON THE FIBARO SYSTEM

Fibaro is a system that does not require any additional conductors; it is based on the Z-Wave technology. Fibaro offers a wide array of advantages in comparison to other, similar systems. In general, radio-based systems establish a direct connection between the receiver and the transmitter. The radio signal is attenuated by every obstacle along its path (in the household e.g. walls, furniture, etc.). In the worst case the radio system ceases to function. The advantage of the Fibaro System is the fact that the devices act not only as a signal receiver and transmitter, but also as a signal "repeater". If a direct radio link between the transmitter and the receiver cannot be established, the connection will be carried out with the use of other devices participating in communication.

Fibaro is a bidirectional wireless system. This means that the signal is not only sent to the receivers, but also the receivers send feedback confirming the reception of the signal. This also confirms the condition of receivers, which allows us to check whether or not a device has actually been switched on. The safety of transmission of the Fibaro System is comparable with a wire-linked bus system.

Fibaro operates in the free band for data transmission. The frequency depends on radio regulations in individual country. Each Fibaro network has its own unique network identification number (home ID), which is why it is possible to co-operate two or more independent systems in a single building without any interference.

Although the Z-Wave technology is fairly new, it has already been accepted as an official standard, just like Wi-Fi. Numerous manufacturers from various fields offer solutions based on Z-Wave technology, which are compatible with one another. This makes the system fit for the future and allows for further development. For more information go to www.fibaro.com.

Fibaro establishes a dynamic network structure. From the moment of start-up, the location data of respective devices of the Fibaro System is updated automatically, in real time, by confirming their condition in the working „mesh“ network.

II. Sensor Installation

- Before the installation make sure to switch off the alarm system, or any other system to which the device is to be connected.
- Connect the Fibaro Sensor according to the diagram.
- Place the Fibaro Sensor in the sensor housing.
- Arrange the antenna (instructions can be found below the diagrams).

EXPLANATION OF CONDUCTOR MARKINGS:

P – (POWER) – power supply conductor, red
 GND - (GROUND) – ground conductor, blue
 IN1 – input no. 1
 IN2 – input no. 2
 TP – (TEMP_POWER) – power supply conductor of the DS18B20 temperature sensor, brown (3.3V)
 TD – (TEMP_DATA) – signal conductor of the DS18B20 temperature sensor, white
 ANT – antenna, black
 OUT1 – output no. 1 assigned to input IN1
 OUT2 – output no. 2 assigned to input IN2
 B – maintenance button (used to add devices to and remove devices from the system)

ANTENNA ARRANGEMENT INSTRUCTIONS:

- Lay down the antenna as far as possible from metal elements (connection conductors, ring brackets etc.), in order to prevent any interference of the radio signal.
- Metal surfaces in close vicinity (e.g. metal embedded boxes, metal door trims) may impair the reception capability!
- You should not cut off or shorten the antenna. Its length is suited ideally to the band at which the system functions.

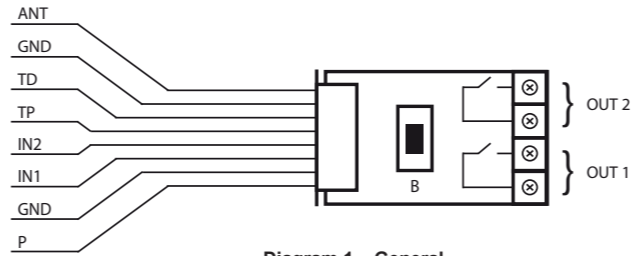

Diagram 1 – General

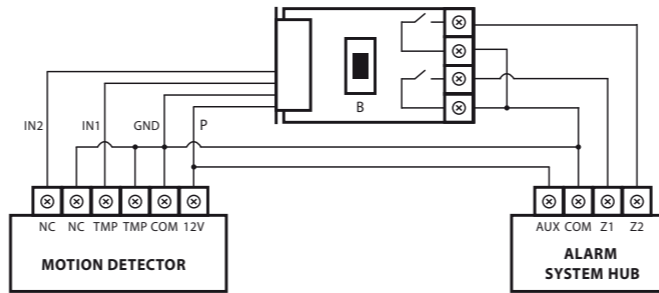

Diagram 2 – Connection to a regular alarm line

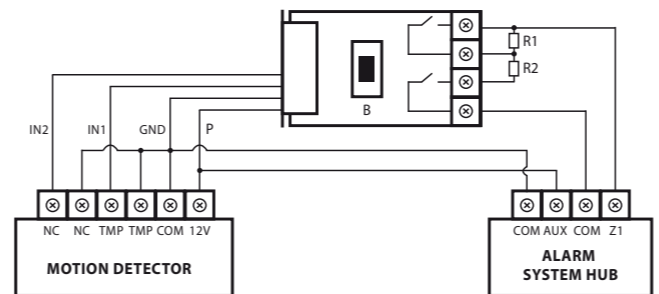

Diagram 3 – Connection to a parametric alarm line

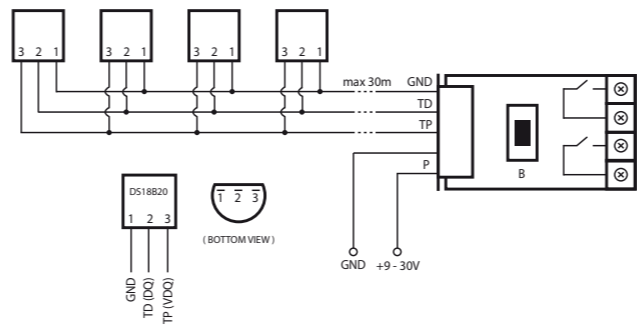

Diagram 4 – Connection to DS18B20 sensors

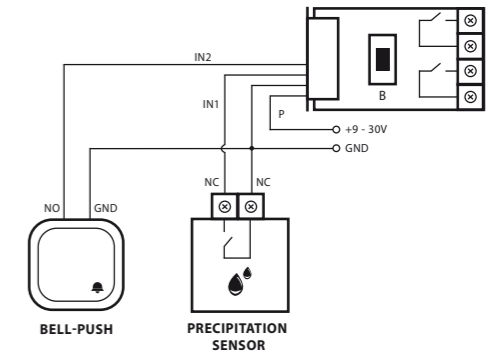

Diagram 5 – example connection to a precipitation sensor

- Note!**
Do not remove the protective layer surrounding the module. Make sure that no metal parts of other devices or conductors come into close contact with the installed Sensor.
- Note!**
Do not connect other sensors than DS18B20 to the 1-wire line (terminals TP and TD).
- Note!**
Condition of outputs OUT1 and OUT2 is dependent only on the condition of corresponding inputs, irrespective of parameter settings or addition of device to the Z-wave network.
- Note!**
Only the B button starts the device's programming process (Include/Exclude).
- Note!**
Every time when any changes are made to the configuration of TP and TD lines (1-wire), e.g. when DS18B20 sensor(s) is (are) included/excluded, it is necessary to execute the procedure of exclusion and repeated inclusion of the sensor module to the central hub. It should be remembered that the system shall enter into the programming mode only once all the connected sensors have been detected (about 10 s).
- Note!**
It is prohibited to connect the TP and TD lines to devices that are not compatible with the 1-wire protocol. Unused lines should be left insulated.

INSTRUCTIONS FOR ARRANGEMENT OF THE DS18B20 SENSOR:

The DS18B20 sensor may easily be installed wherever very precise temperature measurements are required. Moreover, if proper protective measures are undertaken, the sensor may be used in humid environments or under water, it may be embedded in concrete or placed under the floor.

GLOSSARY OF TERMS:

- INCLUSION** – the device sends out a Node Info frame, which makes it possible to add it to the Fibaro system (Home Center)
- EXCLUSION** – removal of device from the Fibaro system
- ASSOCIATION** – controlling other devices of the Fibaro system
- MultiChannel Association** - controlling other multi-channel devices of the Fibaro system

III Fibaro Sensor start-up

1. Installation of the Universal Binary Sensor Module

- STEP 1**
Connect the device according to the wiring diagram shown in figure 1. Engage the supply voltage. [Inclusion / Exclusion] of the Fibaro Sensor [to / from] the Z-Wave network
- STEP 2**
The Fibaro Module must be in range of the Home Center 2 controller, because the procedure of inclusion to the Fibaro system requires direct communication with the controller.
- STEP 3**
Recognition of B button, which allows for proper inclusion of device.
- STEP 4**
Setting the Home Center 2 controller to the inclusion or exclusion mode (see: Home Center 2 controller instructions).
- STEP 5**
The Fibaro Sensor is added to the network by quickly pressing the B button three times (the button is located in the center of the device).
- STEP 6**
Correct inclusion of the device to the network will be signaled by Home Center 2 (see: Home Center 2 central hub operation instructions).

2. Resetting the Fibaro Sensor

There are two procedures you can follow in order to reset the Fibaro Sensor.

- Method I**
Resetting in the course of the procedure of excluding the Fibaro Module from an existing Z-wave network. Devices may be excluded with the use of a controller, which offers the option to exclude devices from or include devices to the Z-wave network (see: controller instructions).
- Method II**
Resetting by cutting off the power supply and re-connecting the power supply while holding down the B button – after 10 seconds, after another cut-off and re-connection of power supply the settings of the device will be reset.

3. Controlling the Fibaro Sensor with the Home Center 2 controller

The FGBS221 Sensor is a multi-channel device. This means that it is equipped with two independent input circuits and a 1-wire bus allowing it to be connected to four DS18B20 temperature sensors. As a result, each device connected to the Sensor is represented by an independent icon in the system.

After the Fibaro Sensor has been added to the network, it shall be represented by appropriate icons in the Home Center 2 controller, depending on the number of connected devices (3 – 7 icons).

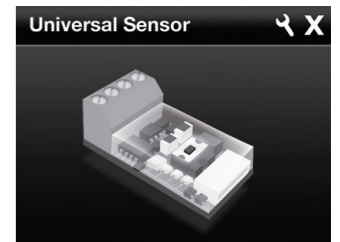

Fig. 1 - Fibaro Sensor icon in the Home Center controller

In the event of including the Sensor without any sensors connected (or with sensors connected only to IN1 and IN2), the device will be represented by three icons. If DS18B20 sensors are also connected, the devices will be represented by additional temperature icons.

	
Note!	
<div><div>If the number of temperature sensor icons is different than the actual number of sensors connected to the device, or if the temperature readings are incorrect, you should inspect the connections on the 1-wire bus, in particular the connection between respective sensor outputs and the line and the total length of the bus (bus bar), which should not exceed 30m.</div></div>	
	

IV Association

Association allows the Fibaro Sensor to directly control another device of the Z-wave network, e.g. Dimmer, Switch (ON-OFF), Roller Shutter or scenes (scene control is only possible via the Home Center 2 controller).

	
NOTE!	
<div><div>Association allows for direct transmission of control commands between devices and takes place without the participation of the main controller. Owing to this mechanism the Sensor may communicate with devices even if the central control hub is completely destroyed, e.g. in the event of a fire.</div></div>	
	

The Fibaro Sensor makes it possible to configure three association groups.

Group I is assigned to input IN1
Group II is assigned to input IN2

Group III reports on the condition of the device, only one device may be assigned to the group.

The Fibaro Sensor allows for control over 5 regular devices and 5 multi-channel devices per group, out of which 1 field is reserved for the network controller.

In order to add an association (with the use of the Home Center 2 controller) go to device options by clicking this icon: 

Select the “device options” tab. Next, specify which devices will be associated and with which groups. Sending of changed configuration to the device might take couple of seconds.

V Configuration

The Universal Binary Sensor offers a wide range of advanced settings, the parameters listed below are available in the Fibaro configuration interface.

In order to configure the Fibaro Sensor (using the Home Center 2 controller) go to the device options by clicking on the icon: 
Next, select the “device options” tab.

Device parameters:

Parameter No. 1
Type of input no. 1: Input I alarm cancellation delay. Additional delay after an alarm from input IN1 has ceased. The parameter allows you to specify additional time, after which the input no. 1 alarm is cancelled once its violation has ceased.
Default value: 0
Possible parameter settings: 0 – 65535 s
Parameter 2 [byte]

Parameter No. 2
Type of input no. 2: Input II alarm cancellation delay. Additional delay after an alarm from input IN2 has ceased. The parameter allows you to specify additional time, after which the input no. 2 alarm is cancelled once its violation has ceased.
Default value: 0
Possible parameter settings: 0 – 65535 s
Parameter 2 [byte]

Parameter No. 3
Type of input no. 1: Default value: 1 – INPUT_NC (Normal Close) Possible parameter settings:
0 – INPUT_NO (Normal Open)
1 – INPUT_NC (Normal Close)
2 – INPUT_MONOSTABLE
3 – INPUT_BISTABLE

Parameter No. 4
Type of input no. 2: Default value: 1 - INPUT_NC (Normal Close) Possible parameter settings:
0 – INPUT_NO (Normal Open)
1 – INPUT_NC (Normal Close)
2 – INPUT_MONOSTABLE
3 – INPUT_BISTABLE

Parameter No. 5
Type of transmitted control frame for association group 1, activated via input IN1. The parameter allows to specify the type of alarm frame or to force transmission of control commands (BASIC_SET) Default value: 255 – BASIC_SET
Possible parameter settings:
0 – Frame ALARM GENERIC
1 – Frame ALARM SMOKE
2 – Frame ALARM CO
3 – Frame ALARM CO2
4 – Frame ALARM HEAT
5 – Frame ALARM WATER
255 – Control frame BASIC_SET

Parameter No. 6
Type of transmitted control frame for association group 2, activated via input IN2. The parameter allows to specify the type of alarm frame or to force transmission of control commands (BASIC_SET) Default value: 255 - BASIC_SET
Possible parameter settings:
0 – Frame ALARM GENERIC
1 – Frame ALARM SMOKE
2 – Frame ALARM CO
3 – Frame ALARM CO2
4 – Frame ALARM HEAT
5 – Frame ALARM WATER
255 – Control frame BASIC_SET

Parameter No. 7
Value of the parameter specifying the forced level of dimming / opening sun blinds when comes “switch on” / “open” command to devices from association group no. 1. In the case of alarm frames the alarm priority is specified. Default value: 255
Possible parameter settings: (1 – 99) and 255
Value of 255 makes it possible to activate the device when using the Dimmer module it means activating the device and setting it to the previous stored condition, e.g. when Dimmer is set to 30%, then deactivated, and then reactivated using command 255, it will automatically be set to the previous condition, i.e. 30%.

Parameter No. 8
Value of the parameter specifying the forced level of dimming / opening sun blinds when comes “switch on” / “open” command to devices from association group no. 2. In the case of alarm frames the alarm priority is specified. Default value: 255
Possible parameter settings: (1 – 99) and 255
Value of 255 makes it possible to activate the device; when using of the Dimmer module it means activating the device and setting it to the previous stored condition, e.g. when Dimmer is set to 30%, then deactivated, and then reactivated using command 255, it will automatically be set to the previous condition, i.e. 30%.

Parameter No. 9
Deactivating transmission of the frame cancelling the alarm or the control frame deactivating the device (Basic). It allows for disabling the deactivation function or the alarm cancellation function for devices associated with the appropriate input of the Fibaro Sensor. Default value: 0, in the case of association group no. 1 and 2 the information is sent
Possible parameter settings: 0 – in the case of association group no. 1 and 2 the information is sent
1 – in the case of association group no. 1 the information is sent. In the case of association group no. 2 the information is not sent.
2 – in the case of association group no. 1 the information is not sent. In the case of association group no. 2 the information is sent.
3 - for 1 and 2 association groups information is not sent.
NOTE: Information concerning alarm violation or activation commands for devices from association groups are always sent.

Parameter No. 10
Interval between successive readings of temperature from all sensors connected to the device. Default value: 20 s
Possible parameter settings: 1 – 255 s
Note: taking temperature readings from the sensor does not result in sending a temperature condition report to the central hub.

Parameter No. 11
Interval between forcing to send report concerning the temperature conditions. The forced report is sent immediately after the next reading of temperature from the sensor, irrespective of the settings of parameter no. 12.
Default value: 200 s
Possible parameter settings: 0 – 255 s
0 – deactivating the function
Note: Frequent sending of temperature condition reports is reasonable when the sensor is located somewhere where can occur rapid changes of ambient temperature. In other cases it is recommended to leave the parameter set to the default value.

Parameter No. 12
Insensitiveness to temperature changes. This is the maximum acceptable difference between the last reported temperature and the current temperature taken from the sensor. If the temperatures differ by the set value or more, then a report with the current temperature value is sent to the device assigned to association group no. 3. Intervals between taking readings from sensors are specified by parameter no. 10.
Default value: 8 [0.5oC]
Possible parameter settings:0 – 255 [0oC to 16oC] [0 oF – 28.8oF]
In order to set the appropriate value of the parameter, the following formula should be used:
x = delta T x 16 - for Celsius
x = delta T x 80 / 9 - for Fahrenheit
x – parameter value
delta T – maximum acceptable temperature gradient in Celsius or Fahrenheit
If the value is set to 0, then information about the temperature will be sent every time, immediately once the readings have been taken from the sensor.

Parameter No. 13
Transmitting the alarm or control frame in “broadcast” mode (i.e. to all devices within range), information sent in this mode is not repeated by the mesh network.
Default value: 0
Possible parameter settings:
0 – IN1 and IN2 Broadcast inactive
1 – IN1 broadcast mode active, Sensor 2 broadcast mode inactive
2 – IN1 broadcast mode inactive, Sensor 2 broadcast mode active
3 – IN1 and IN2 broadcast mode active
NOTE!
If the “broadcast” mode of information transmission is activated for a given channel, then transmission of information in “singlecast” mode to devices assigned to the association group of this channel is deactivated.

Parameter No. 14
Scene activation functionality. Default value: 0
Possible parameter settings:
0 – deactivation of functionality
1 – activation of functionality
The device offers the possibility of sending commands compatible with Command class scene activation. Information is sent to devices assigned to association group no. 3.
Controllers such as Home Center 2 are able to interpret such commands and basing on these commands they activate scenes, to which specific scene IDs have been assigned. The user may expand the functionality of the button connected to inputs IN1 and IN2 by distinguishing the actions of keys connected to those inputs. For example: double click would activate the scene “goodnight” and triple click would activate the scene “morning”.
Scene ID is assigned in the following manner:
input IN1: switch from “off” to “on” ID 10 switch from “on” to “off” ID 11
remaining IDs are recognized correctly if the value of parameter no. 3 was set to 2
holding down ID 12
releasing ID 13
double click ID 14
triple click ID 15
input IN2: switch from “off” to “on” ID 20 switch from “on” to “off” ID 21
remaining IDs are recognized correctly if the value of parameter no. 4 was set to 2
holding down ID 22
releasing ID 23
double click ID 24
triple click ID 25
NOTE!!! Inputs IN1 and IN2 are used to control the condition of the device. Each of them may force two conditions for corresponding device channels: on / alarm, off / no alarm. If monostable keys are used and the value of parameter no. 3 or no. 4 is set to 2, change of the state of corresponding channel will be able after a single click.

VI Additional functionality

Alarm frame servicing

The Fibaro system makes it possible to set the device’s reaction to alarm events (reaction to the frame SENSOR_ALARM_REPORT). The Fibaro Sensor transmits alarm frames of different types, depending on the settings in parameters no. 5 and 6. The user should correctly declare the type of alarm frame for each connected sensor (inputs IN1 and IN2). For example, for a smoke detector connected to input IN1 the user should declare the frame type 1 – ALARM_SMOKE (value of 1 should be entered), to ensure that the remaining devices will correctly recognize information on smoke detector alarm.

VII Sensor operation

The Fibaro Sensor may be operated with the following operator elements:

- Any controller compatible with the system (e.g. Home Center 2 controller)
- Cellular phone (e.g. iPhone or phones of other manufacturers with the proper control application)
- PC, with the use of an Internet browser
- Tablet devices (e.g. iPad)
- With the use of the maintenance button B located inside the housing

VIII Procedure to be followed in the case of interference

The Device does not react to a programmed transmitter:

- Make sure that the maximum range was not exceeded and that there are no obstacles along the signal path which contain metal surfaces, e.g. metal cabinets, ferroconcrete ceiling and load bearing walls, etc.
- Make sure that the device is not in the programming mode.
- Possibly repeat the programming process.

IX GUARANTEE

1. The Guarantee is provided by FIBAR GROUP Sp. z o.o. (hereinafter “Manufacturer”), based in Poznan, ul. Lotnicza 1; 60-421 Poznan, entered in the register of the National Court Register kept by the District Court in Poznań, VIII Economic Department of the National Court Register, no. 370151, NIP 7811858097, REGON: 301595664.

2. The Manufacturer is responsible for equipment malfunction resulting from physical defects (manufacturing or material) of the Device for 12 months from the date of its purchasing.

3. During the Guarantee period, the Manufacturer shall remove any defects, free of charge, by repairing or replacing (at the sole discretion of the Manufacturer) any defective components of the Device with new or regenerated components, that are free of defects. When the repair impossible, the Manufacturer reserves the right to replace the device with a new or regenerated one, which shall be free of any defects and its condition shall not be worse than the original device owned by the Customer.

4. In special cases, when the device cannot be replaced with the device of the same type (e.g. the device is no longer available in the commercial offer), the Manufacturer may replace it with a different device having technical parameters similar to the faulty one. Such activity shall be considered as fulfilling the obligations of the Manufacturer. The Manufacturer shall not refund money paid for the device.

5. The holder of a valid guarantee shall submit a guarantee claim through the guarantee service. Remember: before you submit a guarantee claim, contact our technical support using telephone or e-mail. More than 50% of operational problems is resolved remotely, saving time and money spent to initiating guarantee procedure. If remote support is insufficient, the Customer shall fill the guarantee claim form (using our website - www.fibargroup.com) in order to obtain claim authorization. When the guarantee claim form is submitted correctly, the Customer shall receive the claim confirmation with a unique number (Return Merchandise Authorization -RMA).

6. The claim may be also submitted by telephone. In this case, the call is recorded and the Customer shall be informed about it by a consultant before submitting the claim. Immediately after submitting the claim, the consultant shall provide the Customer with the claim number (RMA-number).

7. When the guarantee claim form is submitted correctly, a representative of the Authorised Guarantee Service (hereinafter as “AGS”) shall contact the Customer.

8. Defects revealed within the guarantee period shall be removed not later than 30 days from the date of delivering the Device to AGS. The guarantee period shall be extended by the time in which the Device was kept by AGS.

9. The faulty device shall be provided by the Customer with complete standard equipment and documents proving its purchase.

10. Parts replaced under the guarantee are the property of the Manufacturer. The guarantee for all parts replaced in the guarantee process shall be equal to the guarantee period of the original device. The guarantee period of the replaced part shall not be extended.

11. Costs of delivering the faulty device shall be borne by the Customer. For unjustified service calls, the Service may charge the Customer with travel expenses and handling costs related to the case.

12. AGS shall not accept a complaint claim only when:

- the Device was misused or the manual was not observed,
- the Device was provided by the Customer incomplete, without accessories or nameplate,
- it was determined that the fault was caused by other reasons than a material or manufacturing defect of the Device
- the guarantee document is not valid or there is no proof of purchase,

13. The Manufacturer shall not be liable for damages to property caused by defective device. The Manufacturer shall not be liable for indirect, incidental, special, consequential or punitive damages, or for any damages, including, inter alia, loss of profits, savings, data, loss of benefits, claims by third parties and any property damage or personal injuries arising from or related to the use of the Device.

14. The guarantee shall not cover:

- mechanical damages (cracks, fractures, cuts, abrasions, physical deformations caused by impact, falling or dropping the device or other object, improper use or not observing the operating manual);
- damages resulting from external causes, e.g.: flood, storm, fire, lightning, natural disasters, earthquakes, war, civil disturbance, force majeure, unforeseen accidents, theft, water damage, liquid leakage, battery spill, weather conditions, sunlight, sand, moisture, high or low temperature, air pollution;
- damages caused by malfunctioning software, attack of a computer virus, or by failure to update the software as recommended by the Manufacturer;
- damages resulting from: surges in the power and/or telecommunication network, improper connection to the grid in a manner inconsistent with the operating manual, or from connecting other devices not recommended by the Manufacturer.
- damages caused by operating or storing the device in extremely adverse conditions, i.e. high humidity, dust, too low (freezing) or too high ambient temperature. Detailed permissible conditions for operating the Device are defined in the operating manual;
- damages caused by using accessories not recommended by the Manufacturer
- damages caused by faulty electrical installation of the Customer, including the use of incorrect fuses;
- damages caused by Customer’s failure to provide maintenance and servicing activities defined in the operating manual;
- damages resulting from the use of spurious spare parts or accessories improper for given model, repairing and introducing alterations by unauthorized persons;
- defects caused by operating faulty Device or accessories.

15. The scope of the guarantee repairs shall not include periodic maintenance and inspections, in particular cleaning, adjustments, operational checks, correction of errors or parameter programming and other activities that should be performed by the user (Buyer). The guarantee shall not cover natural wear and tear of the Device and its components listed in the operating manual and in technical documentation as such elements have a defined operational life.

16. If a defect is not covered by the guarantee, the Manufacturer reserves the right to remove such defect at its sole discretion, repairing the damaged or destroyed parts or providing components necessary for repair or replacement.

17. This guarantee shall not exclude, limit or suspend the Customer rights when the provided product is inconsistent with the purchase agreement.

	
This Device may be used with all devices certified with Z-Wave certificate and should be compatible with such devices produced by other manufacturers.	
Any device compatible with Z-Wave may be added to Fibaro system.	

FIBARGROUP FIBARO

In case of any technical questions contact customer service centre in your country.

www.fibargroup.com